

**DOI: 10.7596/taksad.v7i5.1912**

**Citation:** Alexeev, I., & Sorova, I. (2018). Phonocadencies in Epic Genres: Toyuk and Olonkho. Journal of History Culture and Art Research, 7(5), 189-199. doi:<http://dx.doi.org/10.7596/taksad.v7i5.1912>

## Phonocadencies in Epic Genres: Toyuk and Olonkho

Ivan Egorovich Alexeev<sup>1</sup>, Irina Nikolaevna Sorova<sup>2</sup>

### Abstract

This article deals with structurally-phonomorphological and typical acoustic phonocadency in Yakut toyuk and olonkho, performed by outstanding artists of folklore and professional storytelling S.A. Zverev and G.G. Kolesov. Experimentally-linguistic analysis was carried out with computer program "Speech Analyzer".

Phonocadency as a structural part of epic chant has been specific acoustic complex of components of intonation (quantitativeness, tonality and dynamic indicators). It has three kinds of realization in toyuk, olonkho and algys: initial, medial and final in melodic axis. Most often it functions as a phonoproclitic-enclitic component with various vocal modulations in a form of vibrato and kylaakh (throaty signs of chant). Initial and medial phonocadencies are less quantitative than final ones. In general, these acoustic indicators serve as more plangent exclamation in epic chants. Factual and relative phonetic characteristics of phonoproclitics, phonomedial and phonoenclitics of S.A. Zverev's toyuks have typological commonality with epic pieces of art (olonkho, algys) and are etiquette and universal signs, which symbolize the core of Yakut musical culture of oral traditions. Initial and final phonocadencies of Nyurgun Bootur's songs from Oyunsky's olonkho are expressed by generating physiological vibrato and various vocal modulations. They demonstrate strength and frequency of vocal timbre and also they reveal epic image of a hero.

**Keywords:** Phonocadency, Phonoproclitics, Phonoenclitics, Toyuk, Olonkho, Acoustic parameters, Harmony-melodic archaic, Cliché.

<sup>1</sup> Doctor of philological sciences, professor, Institute of Languages and Cultures of the Peoples of the North-East of the Russian Federation, North-Eastern Federal University, Yakutsk, Russia. E-mail: khomusujb@mail.ru

<sup>2</sup> Candidate of philological sciences, assistant professor, Institute of Languages and Cultures of the Peoples of the North-East of the Russian Federation, North-Eastern Federal University, Yakutsk, Russia. E-mail: isorova@mail.ru

## Introduction

In Yakut musical culture of oral tradition, styles and formulas reflecting background information have been formed for centuries (Gabyshev, 2009, p.5); they symbolized traditional core of collective memory of the nation and life-giving stream of its mentality and feelings (Zhirkov, 2011, p.141).

In musicological literature, folk songs are divided into two styles – *djeretii* and *degereng*, they also have their own genres which compose the basis of musical drama of syncretic genre of olonkho, toyuk, algys and songs of creotonal intonation (Alexeeva, 1994, p.3). These two styles include flowing and diverse examples of deep harmony-melodic archaic and elastic diatonics of new mass chants (Alexeev, 1976, p.270). If olonkho and algys are subdivided into speech, recitative and singing (Efimova, 2003, p.27), then toyuks performed by styles mentioned above have been only singing.

Oral musical communication, taking place in performing olonkho and toyuks, etc. for the last decades has become the subject of research of not only musicologists, but also philologists, folklorists that introspect, trace and analyze real components of vocal phenomena of a performer using technical means of communication.

The aim of this work is to determine structurally-phonomorphological and typical acoustic phonocadencies in Yakut toyuks and olonkho, performed by outstanding artists of folklore and professional storytelling S.A. Zverev and G.G. Kolesov.

More perceived and effective quality of phonocadencies is kylyhaakh (vocal signs of chant), it always transcribes acoustic parameter of epic narration. Kylyhaakh doesn't have certain scientific definition in linguistic culturology. Within styles of Yakut chant *degereng* and *djeretii*, musicologists characterize kylyhaakh as a creotonal (Alexeeva, 1994, p.3), harmony-melodic archaic (Alexeev, 1976, p.270) and specific throaty sound (Krivoshapko, 1969, p.22). Its phonomorphological and acoustic realizations in performance of olonkho songs are defined as "classical cliché", possessing higher informative saturation (Gabysheva, 2009, p.5).

As a matter of fact, phenomenon of kylyhaakh can be postulated as a relict phonoepic layer of Yakut folklore legacy, in which acoustic parameters are revealed as a result of natural physiological modulations, the so-called false vocal ligaments. Such peculiarity of voice, dominating in a genre of throaty singing of Mongolian, Tuvian, Altai and Bashkirian nations forms two-voice, like in Tuvian styles "sygyt", "khargyraa", "borbyngnaadyr". As it concerns kylyhaakh, it is as a "product" of false vocal ligaments, it can be supposed that it is a vestigial phenomenon of Yakut kind of "throaty singing". At present in a style of toyuk, there are two types of kylyhaakh: natural and falsetto – by means of "untie" of speech vocal ligaments. Naturally, all demonstrations of kylyhaakh should be studied by methods of physiology, acoustics, philology and to determine the nature of their acoustic-articulatory characteristics.

Legendary pleiades of olonkho and toyuk singers (Ustin Nokhsorov, Sergei Zverev – Kyyl Uola, Marina Petrova, Gavril Kolesov and many others) possessed natural kylyhaakh, and their creation is rich with classical cliché with abundant timbre coloration and specific melism.

## Phonocadencies in Toyuks of Zverev–Kyyl Uola

In this article we concentrated our attention on toyuks of the greatest singer of XXth century S.A. Zverev – Kyyl Uola, in realization of classical toyuk – many-rounded composition with characteristic exclamations «*Djee buo*» 'Well, now listen!' – maneuver effusion of emotionally-communicative condition of a singer, as well as semantic expression of structural image of toyuk. The whole complex of vocal abilities of a singer is used in toyuk with dimensional "infusions" of intonation – throaty sound-formations, presence of kylyhaakh (throaty ringings), they create solo two-voice. Demonstration of two-voice in toyuks of S.A. Zverev – Kyyl

Uola being the matter of physiology than kyliehaakh – vocal falsetto ringings, as some musicologists assume. Here we should mention the most correct statement of G.M. Krivoshapko that kyliehaakhs are specific throaty ringings (Krivishapko, 1969, p.22).

As is known in written fixation of toyuk, it is impossible to reflect all kinds of phonocadential and phonoenclitic formations. They can be perceived and heard only in oral (singing) variation, when in olonkho, toyuk starting from «*Djee buo!*» or whoop like «*E-ee*» (phonoproclitics), ends to plangent «*Urui-aikhal!*», «*A-aa-yy*», etc. phonoenclitics. Such components of toyuk have been originally traditional or classical clichés; in folklore they are denoted like formulas or etiquette elements, possessing higher informative saturation (Gabysheva, 2009, p.27). Besides initial and final clichéd elements of toyuk, the so-called phonomedials are interposed in its shell, they are similar to phonoenclitics by their structure. Taking into account the volume and emotional saturation of the text, there can be two, three or more (Fig.1)

Fig. 1.

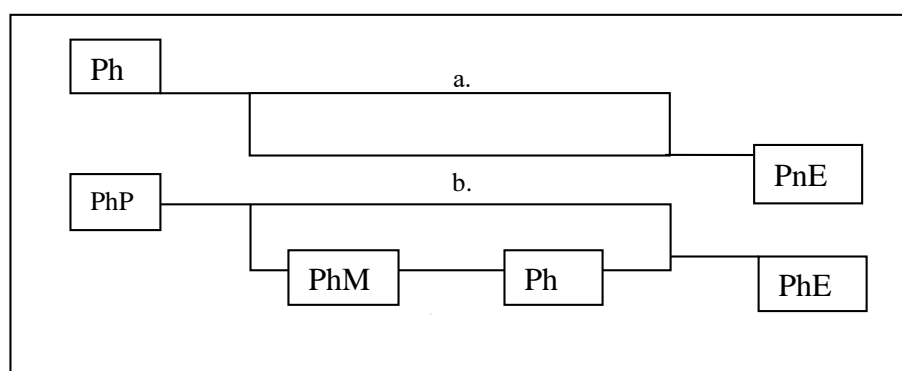

Not only such linguistic realizations of toyuks we examine by opposition “text-singing”, relying on factual phonorealizations received by means of experimentally-linguistic (partially, musicological) tests carried out in the laboratory of experimental philology at Institute of Languages and Culture of North-Eastern peoples of the Russian Federation of M.K. Ammosov North-Eastern Federal University.

Represented by the laboratory of storytelling art (head L.S. Efimova) of the Chair of Folklore, Institute of Languages and Culture of North-Eastern peoples of the Russian Federation, phonorecordings of Zeverev’s – Kyyl Uola toyuks were recorded with the program “Speech Analyzer” on a computer. As a result, intonograms with phonorecordings in files were received; they were analyzed by methodology of phonetic transcript of speech (singing) signal.

Visually-acoustic analysis shows that in a shell of toyuks, phonoproclitics, phonoenclitics and segments of phonomedials are really present in a shell of text. Realization of each takes place in interaction of components of intonation: quantitiveness, tonality, dynamics and rhythm-melodic indicators. Each phonoenclitics is identified by a quality of phono-image, split into canonic segments. All these indicators of polymetric realizations of toyuk are measured and analyzed tabularly and evaluated by the phonolinguistic standards.

The nature of phonoenclitics is defined in comparison with phonomedials, in intonograms it is represented in a type of amplitude-melodic (and dynamic) realizations. Segmentation of these clichéd modulations is carried out automatically, that is regular to experimenter. The program “Speech Analyzer” appeared to be acceptable enough for determination of structural, intonational and segment characteristics of toyuks; with the help of which it becomes possible to trace various realizations of not only toyuks, but also fragments of olonkho, folk songs, recitative tales, tongue-twisters, etc. identical with signs of speech-formation. In other

words, acoustic parameters of speech, song, toyuk, olonkho can be easily traced by a computer program “Speech Analyzer”.

Out of these processed intonographic materials of Zverev – Kyyl Uola, we can trace not only characteristic phonoenclitic figures, but also the whole system of toyuk formation, their “subtext” informational canons, style maneuvers, communication aspects of oral singing culture of the Sakha people\*. However, according to principle “step by step progress” and according to the aim and task of this research, we shall have an opportunity to determine origin of formation of toyuks’s intonational structure, its canonic phonoenclitics.

It is claimed that phonoenclitics is vocal background, forming final component of toyuk as an intonational-compositional completeness of the work. Characteristics of phonoenclitics of each performer is shown individually. More typical parameters of phonoenclitics\*\* can be revealed by experimentally-linguistic analysis.

Out of eight toyuks of Zverev – Kyyl Uola, six were selected. According to intonograms it is possible to determine factual and relative phonetic characteristics of phonoproclictics, phonomedials and phonoenclitics.

Supporting example of this research of phonoenclitics became toyuk “Algys yryata” (“Blessing song”), on intonograms of which four specific phono-formations: intonation-initial (PhP), two medials (PhM1, PhM2) and final (PhE), accompanying three structural song blocks of toyuk (Fig.2). These blocks consist of repeated rhythm-melodic stanzas with few seconds – quart intervals.

**Fig. 2.** Phono-formations of toyuk “Algys yryata”

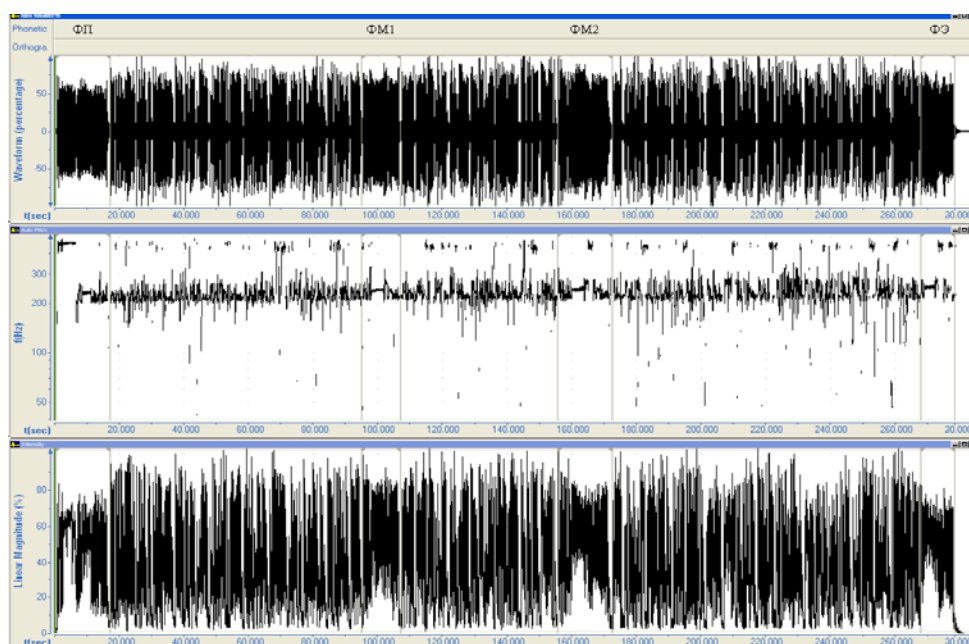

Analysis of rhythm-melodic characteristics of toyuk “Algys yryata” by Zverev – Kyyl Uola reveals us unknown before pictures of singing technique: abundance of tonal modulations, their manifestation between pauses (breathing), dynamic-temporal peculiarities of phono-figured segments, as well as realization of specific for Yakut singing – kilyhaakh. They say that “toyuk is beautiful by its kilyhaakhs”, which in analyzed example

\* By comparative research of this genre of related and unrelated song cultures, it is possible to trace the paradigm of semantic structure of myth-epic styles, cliché and even symbolic core of Turk-Mongolian culture.

\*\* This theme is waiting for its researchers, folklore experimenters, philologists and musicologists.

appears in any fragment of initial, medial and final “Algys yryata”. Kylyhaakh is not only spontaneous phonoformation, it enriches toyuk with specific ringings of throaty modulations, mainly, interacting with emotional semantics forming clear harmonious structure (Novik, 1994, p.154) of semantic field of toyuk.

Let’s consider initial, medial and final phonofigures in toyuks of Zverev – Kyyl Uola.

Phonoproclitics (PhP) (Fig.3) *Djee buo*, starting toyuk is pronounced at 16044 ms and disarticulated into three phonosegments: 6457 ms, 4217 ms, 5370 ms, components of rhythm-melody with personal third-fourth intervals and 20-70% dynamic parameters. However, intervals of frequency of major tone (f.m.t.) between phono-segments form complicated cadential passage -m.10 (450-204 Hz), that between first and second – i.9 (450-220 Hz), and between second and third – -m.3 (270-200 Hz). Such rhythm-melody, synchronously accompanied by positive dynamic indicators is realized by, as if, in two planes: first – monotonous-vibrato for 6457 ms; second – vibrato-kylyhaakhs for 9587 ms. Both phonofigures begin with uniform double kylyhaakhs at different speech registers with intervals i.9. The final phase of second melodic figure of phonoproclitics for 5370 ms forms traditional cadence of toyuk with uniform kylyhaakhs (m.2) and third intervals. It is obvious that kylyhaakhs of Zverev – Kyyl Uola, “regulated” in a context of toyuk have been those figurative means, that end up to phonoproclitics. In contrast with phonoproclitics of olonkho and other works in a style of “djeretii”, pair (m.2) formation of vocal and throaty movements occur, inherent to only Zverev – Kyyl Uola. In Fig.3 it can be seen that kylyhaakhs are formed without mini-pauses, peculiar to kylyhaakhs of falsetto movement of vocal ligaments. So, we can come to conclusion that in Yakut folk singing, two types of kylyhaakhs are inherent: proper-traditional and falsetto (artificial). By acoustic perception, in proper-traditional kylyhaakhs of throaty origin (false ligaments), effect of two-voice is faded. In falsetto with formation of mini-pauses, such effect is smoothed out, that can be shown in findings of intonogram (Fig.3).

**Fig. 3.** Phonoproclitics *Djee buo*

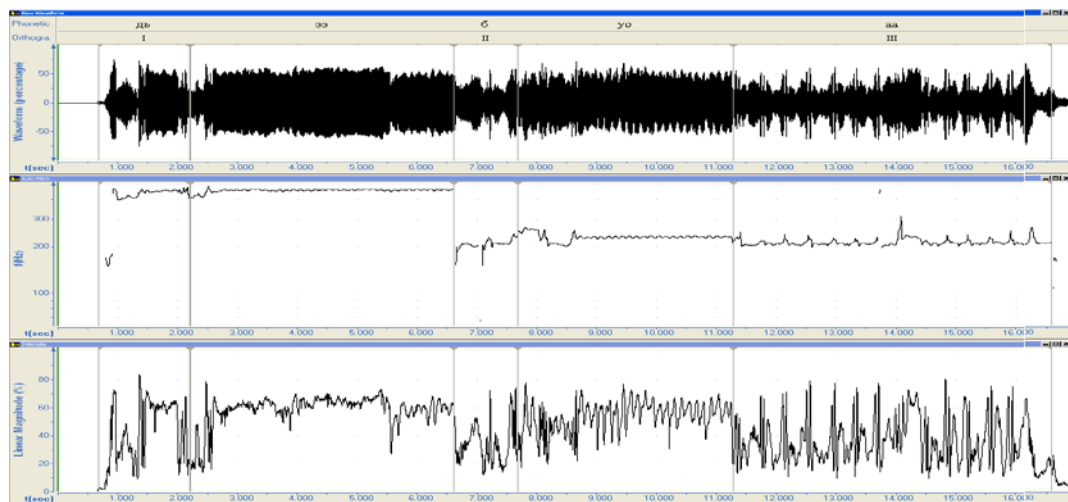

In Fig. 4 and 5 medial phonofigures of toyuk (PhM1, PhM2) are traced, realizing in 9314 and 12309 ms, comparing to phonoproclitics, at different registers of vocal range, rhythm-melodies are formed; they are similar by movement to f.m.t. PhM 1 – 240–207 Hz (m.3); PhM 2 – 240–360–210 Hz (p.5 – m.3).

Fig. 4. Phonomedial 1

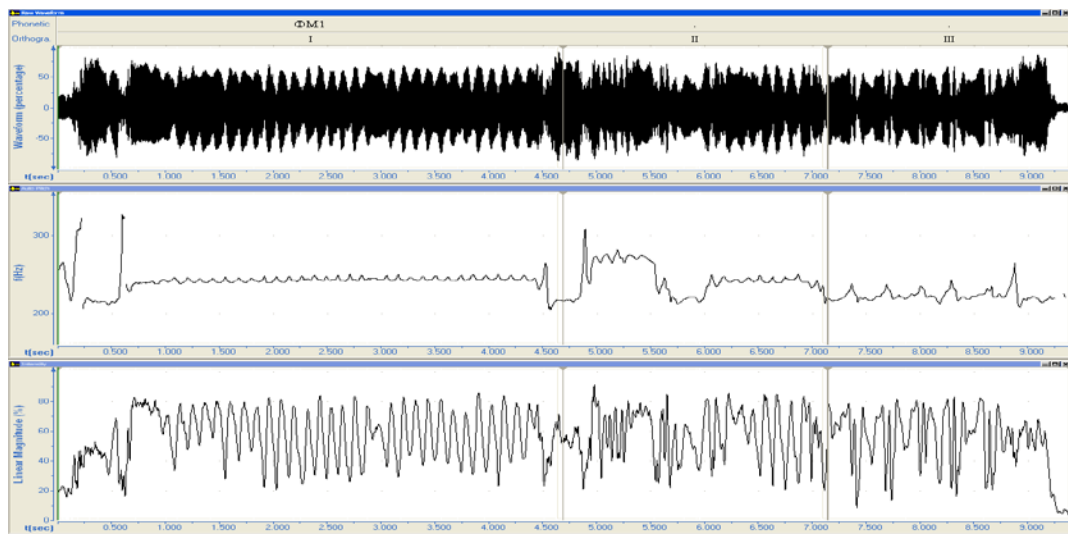
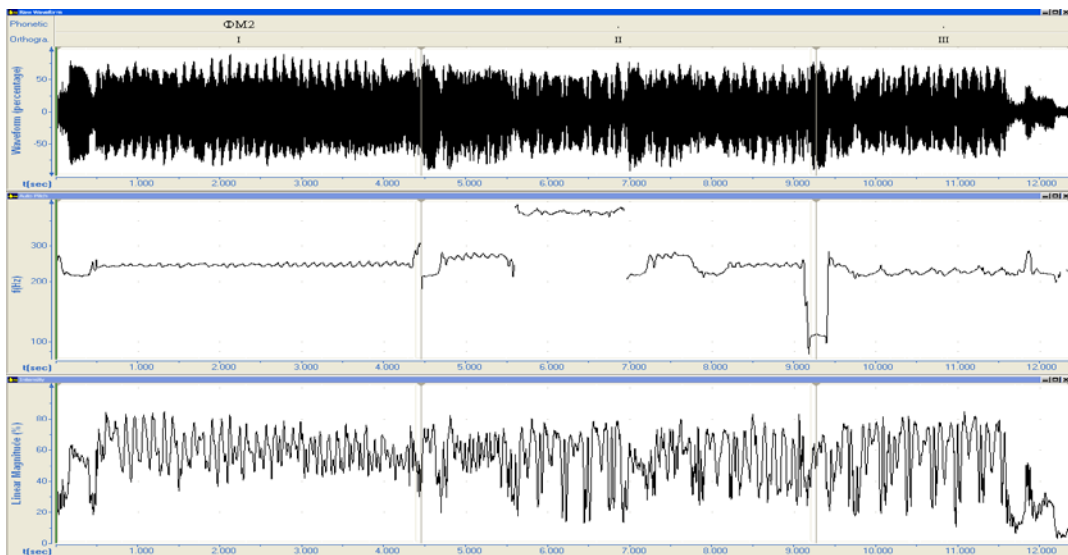

Fig. 5. Phonomedial 2



Such parameters of frequency of major tone, combined with dynamics (40-65%), give evidence to high maneuverability of performing skill of Zverev – Kyyl Uola. Vibrato and kylyhaakhs become style-forming parameters of toyuk. For example, final in phonofigures of kylyhaakhs, fading within limits of 205-210 Hz, they form stable sinusoids with the same type of timbre coloration.

In Fig. 6 phonoenclitics *Urui 'Glory'* of “Algys yryata” is represented, realized at 12166 ms. Rhythm-melody, comparing to phonoproclitics and phonomedial 1, phonomedial 2 forms two monotonous-ascending figures f.m.t (m.6), in which upper element differs from abundance of temporal kylyhaakhs, peculiar to them m.3 ranges in upper register of vocal range (~370 Hz). Throughout phonoenclitics, kylyhaakhs appearing in initial, medial and final phonofigures form specific phonostructure of toyuk, where rhythm-melody with m.6 intervals of f.m.t form two monotonous-ascending figures for ~300 ms with synchronous 20-60 % dynamics. The common rhythm-melody of phonoenclitics can be characterized as a segment, structurally connected with phonoproclitics, phonomedial 1 of toyuk “Algys yryata”, where defining criteria can be considered longitudinal-monotonous vibrato with framings of famous Zverev’s kylyhaakhs.

**Fig. 6.** Phonoenclitics *Urui*

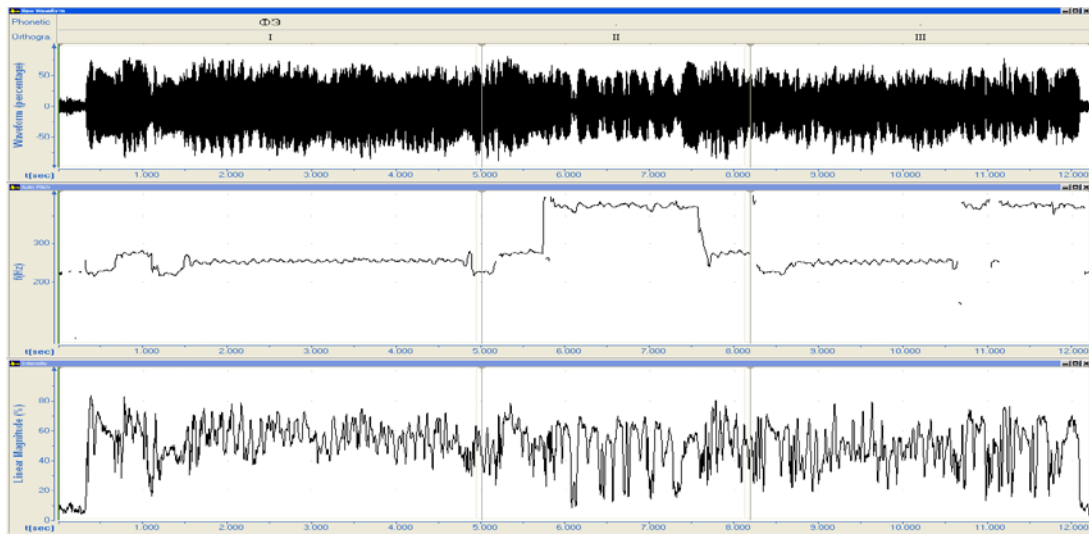

It is clear that all toyuks of Zverev – Kyyl Uola were performed and recorded at different times in unequal conditions, and certainly his performing mood depended upon content of art work. Such circumstances give opportunity for researcher to evaluate rhythm-melodic peculiarity of phonoenclitic variations, clichiness, and the most important, traditionalism.

Let us suppose that phonoenclitics in Fig. 6 is more typical phonofigure for toyuk and let's contrast it with other phonoenclitics of toyuk "Kullustay Bergen", "Sajyn keliite" ("The summer coming"), "Ychchakka ajkhal" ("Glory to the youth").

In Fig. 7 final phono-stanza is traced *Bydan djyllarga byrahaajdaryng 'Farewell for centuries'* (14000 ms) from toyuk "Kullustai Bergen", where the word *Byrahaajdaryng 'Farewell'* becomes phonoenclitics. The model of stair-step-ascending (p.8) of rhythm-melody with following decrease for m.9, in which interpenetration of vibrato with ascending kylaakhs is perceived aurally, as a result of abundant kylaakhs in song block of toyuk.

**Fig. 7.** Phonoenclitics *Byrahaajdaryng*

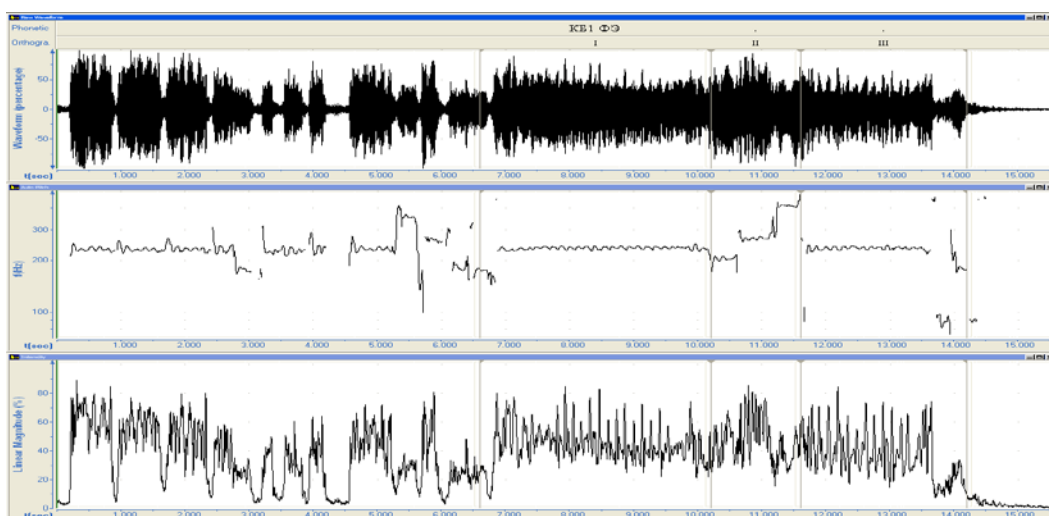

In Fig. 8 phonoenclitics as an example *Unaaryjan kelbit* from toyuk "Sajyn keliite" (8000 ms), where realization of rhythm-melody takes place mainly in monotonous vibrato of movement f.m.t. However, transitional rise of f.m.t. (m.6) in the middle of phonofigure for 1000 ms becomes the element of ascending

kylyhaakh too. Consequently, performer regulating kylyhaakh in the end of toyuk, reaches the highest degree of brilliancy in style of djeretii in his singing

**Fig. 8.** Phonoenclitics *Unaaryjan kelbit*

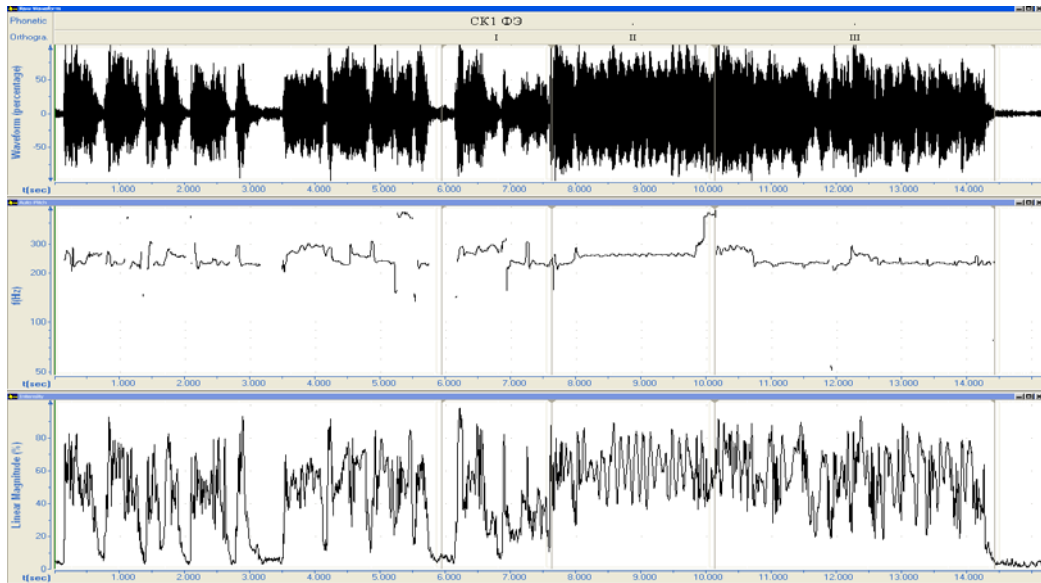

In Fig. 9 intonogram of phonoenclitics *Urui 'Glory'* from toyuk “Ychchattarga urui” (“Glory to the youth”) is represented, in contrast with previous example, ascending-descending-ascending movement of f.m.t. (m.3) in the second phase of rhythm-melody shows that combination of vibrato with kylyhaakhs forms typical for other phonoenclitics configuration of rhythm-melody.

**Fig. 9.** Phonoenclitics *Urui*

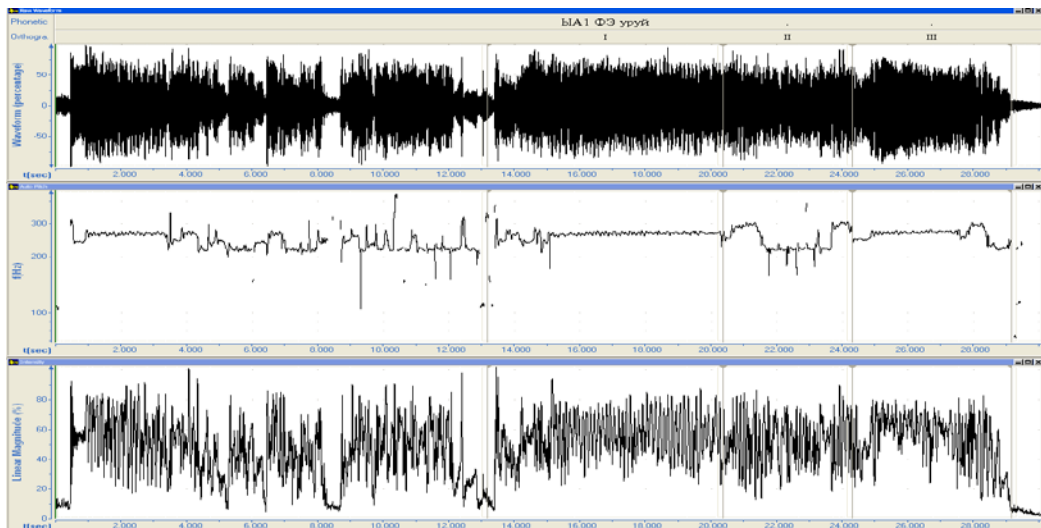

Therefore, rhythm-melodic characteristics of phonocadencies (PhP, PhM, PhE) of Zverev’s – Kyyl Uola toyuks demonstrates the following: Quantitative sign is proportionate with common length of toyuk (8000-15000 mc). Rhythm-melody of phonoenclitics, differing from singing block forms ascending-monotonous, monotonous-ascending-descending figures of f.m.t. Phonoenclitics like phonoproclitics and phonomedial is always accompanied by kylyhaakhs, peculiar phono-formations with the help of throaty (false ligaments) modulations. Kylyhaakhs of falsetto formation are not peculiar to Zverev’s – Kyyl Uola.



### Phonocadencies in Songs Nyurgun Bootur from Olonkho by P.A. Oyunsky

In the set of records “Nyurgun Bootur, the Swift” recorded by G.G. Kolesov in 1968 in “Melody records” there are 13,509 songs and 23,259 recitative blocks. Out of them there are 23 songs of Nyurgun Bootur (Oboyukova, 2016, p.23). This set as a monument of living speech and singing culture of Yakut and Common Turk epic study contributes into research of deep universal means of olonkho, symbolizing the diversity of images of epic works.

In singing block of olonkho, phonocadential system is distinguished; it enriches rhythm-melody and acoustic palette of singing. As a rule, it is framed by natural kылыһаах, function of which is directed towards strengthening of emotional coloration of any segment of a song. Phonocadency of olonkho includes style similar to toyuk and algys.

For experimenting and description, examples with initial and final phonocadencies from three songs of Nyurgun Bootur were selected: 1. from characteristics of personal dignity of a hero; 2. from the song about the struggle with Uot Usutaaky; 3. from the song of valiant victory over heroes from Upward World. Let’s consider results of experimental analysis of third example: phonocadencies in passages of initial *Kyer bu, kyer bu* ‘Listen, listen’ and *Urui buollun* ‘Glory, Glory’.

Initial phonocadency *Kyer bu, kyer bu* (Fig. 2.) is sung in intermittency of 1100 ms, where first segment *kyer bu* is pronounced with the length of 623 ms, second – 453 ms. Vocal elements *ye* and *y* in both components of phonocadencies exceed consonants for many times, as cadentiality is expressed in quantitiveness primarily. However, the most semantic load of phonocadency, bears component of rhythm-melody, where f.m.t. breaks into third intervals and passes in higher (247-206 Hz) tones in first song segment. This is all is accompanied by gradually weakened dynamic component (90 – 74% and 54 – 26%) (Fig. 10.).

Fig. 10. Phonocadency *Kyer bu, kyer bu*

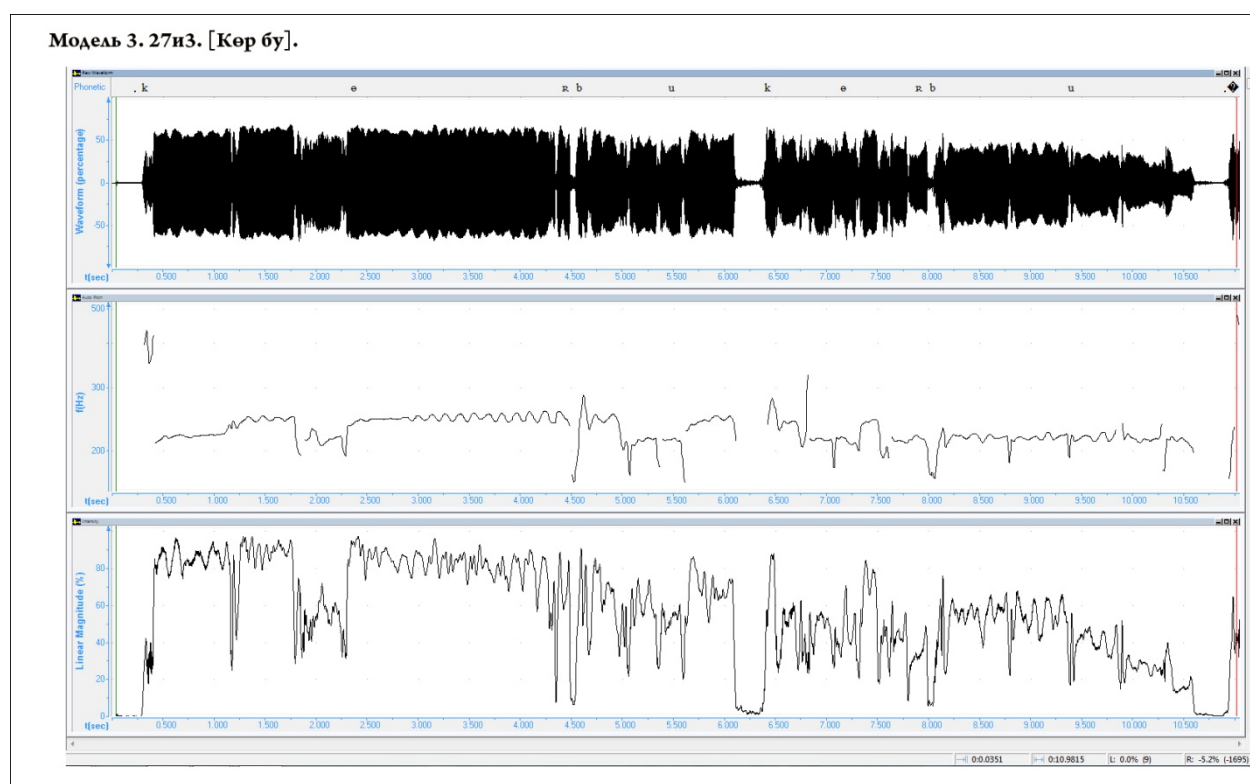

It is obvious that throughout initial phonocadency *Kyer bu, kyer bu* kyliehaakhs are layered in more articulate form in segments *u*. Their acoustic parameters are depicted in few seconds refractions of f.m.t.

**Fig. 11.** Phonocadency *Urui buollun!*

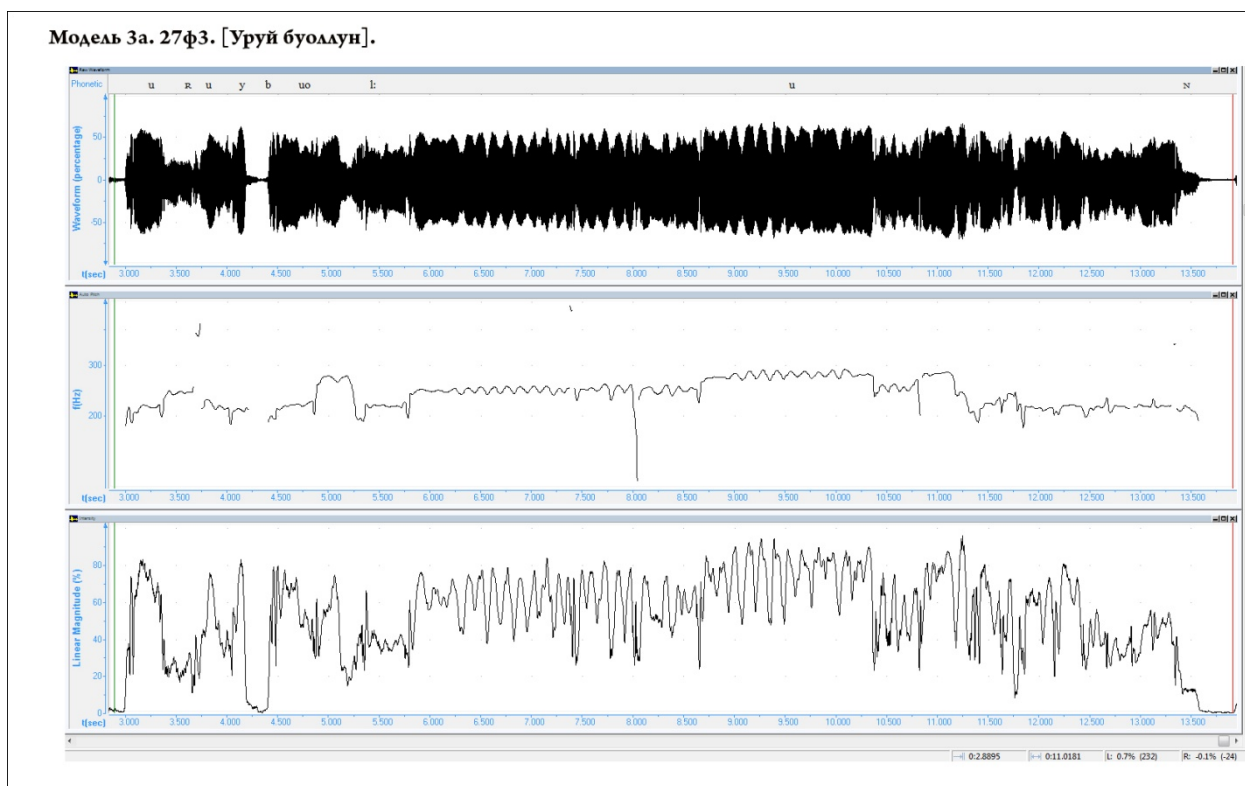

In the final phonocadency *Uruj buollun!* the motive of solemnity is widely represented in sounding of vocal element *y [u:]*, each of them quantitatively makes up more than 800 ms with wide articulation at the end of consonant. The range of f.m.t. of vocalized sounds compose 213-263 Hz, it is equal to pure quart. Musical phrase *Urui buollun!* is framed by natural kyliehaakhs in phoenclitics *-lun*. If we contrast rhythm-melody with dynamic parameters of all phonocadencies then 90% strengthening is at the middle of sound *[u]*, where after transitional kyliehaakh, vibrato is repeated at maximum high frequency of major tone of the voice. Consequently, synchronization of f.m.t. and dynamics of phonocadency becomes semantic core of Nyurgun Bootur's song.

All in all, it can be noted that diversity of nature of G.G. Kolesov's kyliehaakh demonstrates natural strength and purity of timbre. Kyliehaakhs in these phonocadencies bear semantic significance and rhythm-melodic harmony of phenomenon of olonkho's phonocadency.

## Conclusion

1. In phonocadencies of Zverev's – Kyyl Uola toyuks, like in song blocks, monotonous vibrato is inherent and physiological kyliehaakhs are laid on. Combination of vibrato with kyliehaakhs is a peculiarity of singing skill of Zverev – Kyyl Uola, his singing is perceived by a listener like effect of two-voice. Phoenclitic figures of analyzed toyuks allow us to notice that they have typological commonality with epic works (olonkho, algys) and have been etiquette and universal signs, symbolizing the core of Yakut musical culture of oral traditions.

2. In phonocadencies of olonkho performed by G.G. Kolesov, originality of kyliehaakhs like in toyuks of Zverev – Kyyl Uola, is expressed by generating physiological vibrato and various vocal modulations. They

show the strength and purity of vocal timbre. The most important is that kylyhaakhs in following phonocadencies bear semantic significance and rhythm-melodic harmony of phenomenon of folklore legacy of Yakut people.

### **Acknowledgements**

*The publication is supported by Russian Fund of Fundamental Researches Scientific Project № 16-34-00027-the Department of Humanitarian Sciences*

### **References**

Alexeev, E. E. (1976). The problems of harmony formation. Moscow: Music.

Alexeeva, G. G. (1994). From folklore to professional music. Yakutsk.

Efimova, L. S. (2003). Algys Sakha (of Yakut people) in the light of traditions of Turk-Mongolian people. Novosibirsk: Nauka.

Gabysheva, L. L. (2009). Folklore text: symbolic mechanisms of oral memory. Novosibirsk: Nauka.

Krovoshapko, G. M. (1969). Yakut music and olonkho. Application to set of records "Nyurgun Bootur, the Swift".

Novik, E. S. (1994). Archaic beliefs in the light of interpersonal communication. Historic-ethnographic researches into folklore. Moscow: Eastern literature, 110-163.

Oboyukova, V. V. (2016). Gavril Kolesov, the greatest Yakut man that contributed into development of olonkho. Yakutsk: Alaas.

Zhirkov, M. N. (2011). People cannot live without song. Spiritual potential of society in innovative development of Yakutia. Yakutsk: Bichik, 123-138.